

Integrus

Data brochure

Introduction	3
System description and planning	7
System Specifications	15
Transmitter and Modules	17
Radiators and Accessories	21
Receivers, Battery Packs and Charging Units	23
Headphones	25
6-Channel Interpreter Desk and Accessories	27
DCN	29
Index	31

Using this catalogue

The section numbers listed on this page cover the main systems and individual categories within these groups for convenient reference.

It is possible to locate any section quickly by thumbing to the corresponding tab number on the outer margin of each page. The index section at the back of this catalogue includes an alphanumeric listing according to part number.

1. Introduction



1.1 Simultaneous Interpretation

For international conferences with multiple languages, it is obviously of utmost importance that all participants can understand what is being said. That is why a system which enables interpreters to simultaneously interpret the speaker's language is almost indispensable. The interpretations created are then distributed throughout the conference venue, so delegates can select the language of their choice and listen to it through headphones.

1.2 Infra-Red Distribution

The most effective method of distributing the interpretations is by using an infra-red language distribution system. Infra-red means wireless, so delegates have total freedom of movement. It means information integrity, because distributed signals cannot pass beyond the conference hall. And now, with the Bosch Integrus system, it means better-than-ever audio quality, with no interference whatsoever from hall lighting.

In simple terms, an infra-red distribution system consists of a transmitter, one or more radiators and a number of receivers. Various accessories are also available, such as headphones, cables and battery chargers.

The transmitter is the central element in the Integrus system. It accepts inputs from either analog or digital sources, modulates these signals on to carrier waves, then transmits the waves to infra-red radiators located elsewhere in the room. The transmitter accommodates special interface modules to ensure compatibility with these external signal sources. Depending on the transmitter model, up to 32 separate channels can be transmitted simultaneously.

The output of the infra-red radiators is intensity-modulated infra-red radiation. Each delegate is supplied with a pocket receiver, which has a lens to collect the infra-red signal and direct it to a sensor. These signals are then decoded back into interpretation languages, which are chosen by delegates using a channel selector and passed to the delegate's headphones.

The Integrus infra-red (IR) distribution system described in this data brochure can be used with the Digital Congress Network (DCN) as well as with an analogue system such as the CCS 800, which provides a maximum of 6 languages in combination with up to 12 interpreter desks.

1.3 Advanced Digital Technology

The Integrus language distribution system incorporates unique, specially-developed Bosch Ir-Digital technology. This technology is characterized by a number of features:

- The Integrus conforms to IEC 61603, part 7. This is the industry standard for digital infra-red transmission for language distribution.
- The use of the 2-8 MHz frequency band eliminates disturbance from all types of lighting systems.
- Error correction by means of a Reed Solomon coder, plus the bit error rate threshold, ensures a high audio quality.
- The digital transmission protocol used allows additional information to be sent (e.g. synchronization of the number of channels in use)
- The application of digital technology results in a very high sound quality with a signal/noise ratio of 80 dB.

Some of the advantages of this new technology are described in more detail below.

1.4 Characteristics of Infra-red Distribution

Infra-red radiation is an ideal medium for audio distribution. It is invisible to the human eye and can carry multiple channels, each with a separate language, over relatively large distances. And, above all, it is a wireless distribution system, so conference participants can receive interpretations without being physically connected to the system.

1.5 Conference Hall Privacy

Conferences can often involve discussion of sensitive information, where it is important that any audio distribution does not compromise security. As infra-red radiation is unable to pass through opaque structures such as walls, the congress venue itself acts as a barrier to infra-red radiation escaping and being overheard.

1.6 Language Distribution in Adjacent Halls

Infra-red systems are ideally-suited for conference centers with a number of separate halls. Since walls are opaque to infra-red radiation, there is no interference between separate conferences.

1.7 No Interference from Lighting Systems

One of the limitations of traditional infra-red language distribution systems was interference from lighting. The problem was particularly acute with newer (fluorescent) lighting systems, which operate at higher frequencies and therefore cause more interference. The Integrus system has completely solved this problem by using a much higher frequency band – 2 to 8 MHz – for audio distribution. Freedom from interference from all types of venue lighting brings two major advantages: audio quality is greatly improved, and systems can be used much more easily on a rental basis, because they will be compatible with all types of venue lighting.

1.8 Audio Quality

The Integrus system offers greatly improved audio quality. Better compression techniques and a higher signal-to-noise ratio means that the received signal is much clearer, and, as mentioned above, there is no interference from lighting systems. Greater intelligibility makes the system less tiring to use over extended periods. Delegates can therefore maintain their concentration more easily throughout a long conference session.

1.9 Number of Channels

The Integrus gives the user real flexibility in choosing the number of required channels. By using a much higher frequency band (2 to 8 MHz) it offers four quality modes:

- Standard-quality mono (for interpretations). Four channels of this quality can be incorporated in a single carrier signal.
- Standard quality stereo (for reproduction of music or presentations). Two channels of this quality can be incorporated in a single carrier signal.
- Premium-quality mono (with double the bandwidth). Two channels of this quality can be incorporated in a single carrier signal.

- Premium-quality stereo (for excellent reproduction of music or presentations). One channel of this quality can be incorporated in a single carrier signal.

The Integrus can therefore provide a maximum of 32 standard-quality audio channels (which means up to 31 different interpretations + the floor), more than enough to accommodate even the most largest international conferences. It can also be configured for high quality stereo sound, with up to eight different channels available for applications like multimedia presentations or music distribution. Combinations of standard- and premium-quality configuration are also possible.

1.10 Freedom of Movement for Delegates

With an infra-red system, delegates have great freedom in movement throughout the conference room. As the interpretations are transmitted through the air, there is no physical connection to the system, so the only limitations are the walls of the venue itself. The receivers used by delegates to pick up interpretations are lightweight, portable and unobtrusive, and can be easily by slipped into a shirt or jacket pocket.

1.11 User-Friendly Channel Selection

The Integrus receivers ever offer the user the exact amount of channels available. This eliminates having to scroll through unused channels before reaching the required signal. All receivers in the system automatically update themselves if the number of available channels changes.

1.12 Installation and Maintenance of the System

The Integrus system is easy to install. (installation time is largely determined by the time required to position and align the radiators.) Connection of the transmitters is straightforward and quick. The transmitter has slots for modules that enable interfacing with digital or analogue conference systems. All information regarding installation, configuration and system status is given on the transmitter front-panel display. The display also shows the menu, which allows all system parameters to be set or altered. One easy-to-use button is all that is required to select all menu options.

Circuitry in the transmitter and matching circuitry in the radiators allows effective monitoring of the infra-red



radiator function. The status of the radiators is indicated on the transmitter display and by LEDs on each radiator. The system is also easy to maintain. Maintenance of the receivers generally involves recharging or replacing the batteries they use.

Once installed, the system can easily be extended to accommodate more conference delegates, simply by adding the required number of extra receivers. The basic system structure will remain the same.

1.13 Testing Coverage

The Integrus receivers have an ingenious feature, which allows installers to test the coverage of infra-red radiators without the need for measuring equipment. Simply by walking throughout the venue holding a receiver in measuring mode, it is possible to check the coverage at every point. This makes it easy to see whether extra radiators are required or if the positioning of existing ones should be altered.

1.14 Integrated Charging Electronics

A breakthrough in technology has made receiver charging more reliable than ever. The process is regulated from the Integrus system IC, although each receiver now has integrated electronics to allow it to manage its own charging process. This ensures optimum charging performance and maximum battery lifetime.

1.15 Room Coupling

For distributing interpretations to multiple rooms, the Integrus transmitter has a master/slave operation mode. This means that separate (slave) transmitters can be located in the other rooms, providing exactly the same

functionality as the master transmitter and providing local outputs for radiators. This removes the need to connect the radiators required for the additional rooms to one transmitter, which cuts the amount of wiring required and eliminates the risk of capacity overload.

1.16 Emergency or Auxiliary Input

To provide delegates with an additional degree of safety and security, the infra-red transmitter unit includes an additional auxiliary input which overrides all active audio channels. This auxiliary input allows the immediate distribution of emergency messages to all active channels. The auxiliary input may also be used for the distribution of music or other information.

1.17 Music Distribution and Hearing Assistance

The Integrus offers more than just language (interpretation) distribution. Its flexibility and high audio quality also make it suitable for:

- Music distribution. In places as diverse as fitness centers and factories, it can provide a choice of music for listeners in locations throughout the premises
- High-quality audio distribution. Multi-lingual cinemas can offer different language soundtracks in the same hall.
- Hearing assistance. Helps the hard-of-hearing in places like theatres and other public buildings



2. System description and planning

2.1 System overview

Integrus is a system for wireless distribution of audio signals via infra-red radiation. It can be used in a simultaneous interpretation system for international conferences where multiple languages are used. To enable all participants to understand the proceedings, interpreters simultaneously translate the speaker's language as required. These interpretations are distributed throughout the conference venue, and delegates select the language of their choice and listen to it through headphones. The Integrus system can also be used for music distribution (mono as well as stereo).

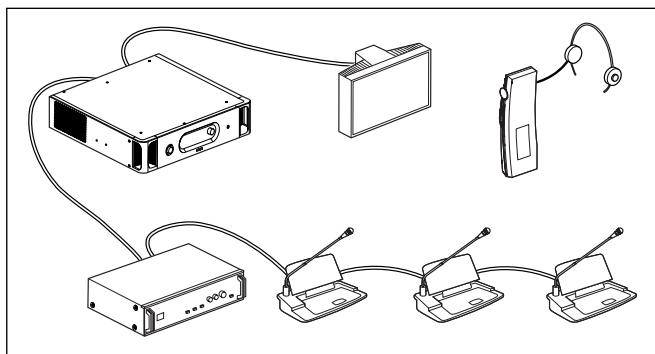

Figure 2.1 Integrus system overview (with DCN-system as input)

The Integrus Digital Infra-red Language Distribution System comprises one or more of the following:

Infra-red transmitter

The transmitter is the core of the Integrus system. Four types are available:

- LBB 4502/04 with inputs for 4 audio channels
- LBB 4502/08 with inputs for 8 audio channels
- LBB 4502/16 with inputs for 16 audio channels
- LBB 4502/32 with inputs for 32 audio channels

Interface modules

One of two different interface modules can be mounted in the transmitter housing to connect the transmitter to a wide range of conference systems:

- LBB 3423 DCN Interface module to connect to the Digital Congress Network (DCN).
- LBB 3422/1x Symmetrical Audio Input and Interpreters Module to connect to analogue discussion and conference systems (such as CCS 800) or to LBB 3222/04 6-channel interpreters desks.

Infra-red radiators

Two types of radiators are available:

- LBB 4511/00 medium-power radiator for small/medium conference venues
- LBB 4512/00 high-power radiator for medium/large conference venues

Both types can be switched between full and half power use. They can be mounted on walls, ceilings or floor stands.

Infra-red receivers

Two multi-channel infra-red receivers are available:

- LBB 4540/04 for 4 audio channels
- LBB 4540/32 for 32 audio channels

They can operate with a rechargeable NiMH battery pack or with disposable batteries. Charging circuitry is incorporated in the receiver.

Charging equipment

Equipment is available for charging and storing 56 infra-red receivers. It is available for portable or fixed-installation applications.

2.2 System technology

2.2.1 IR radiation

The Integrus system is based on transmission by modulated infra-red radiation. Infra-red radiation forms part of the electro-magnetic spectrum, which is composed of visible light, radio waves and other types of radiation. It has a wavelength just above that of visible light. Like visible light, it is reflected from hard surfaces, yet passes through translucent materials such as glass. The infra-red radiation spectrum in relation to other relevant spectra is shown in figure 2.2

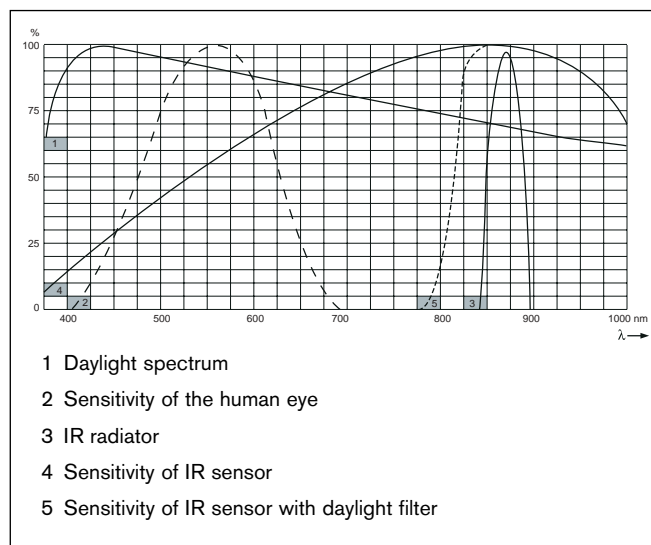

Figure 2.2 Infra-red radiation spectrum in relation to other spectra

2.2.2 Signal Processing

The Integrus system uses high frequency carrier signals (typically 2-8 MHz) to prevent interference problems with modern light sources (see section 2.3.2). The digital audio processing guarantees an constant high audio quality.

The signal processing in the transmitter consists of the following main steps (see figure 2.3):

1. **A/D conversion** - Each analogue audio channel is converted to a digital signal.
2. **Compression** - The digital signals are compressed to increase the amount of information that can be distributed on each carrier. The compression factor is also related to the required audio quality.
3. **Protocol Creation** - Groups of up to four digital signals are combined into a digital information stream. Extra fault algorithm information is added. This information is used by the receivers for fault detection and correction.
4. **Modulation** - A high frequency carrier signal is phase-modulated with the digital information stream.
5. **Radiation** - Up to 8 modulated carrier signals are combined and sent to the IR radiators, which convert the carrier signals to modulated infra-red light.

In the IR receivers a reverse processing is used to convert the modulated infra-red light to separate analogue audio channels.

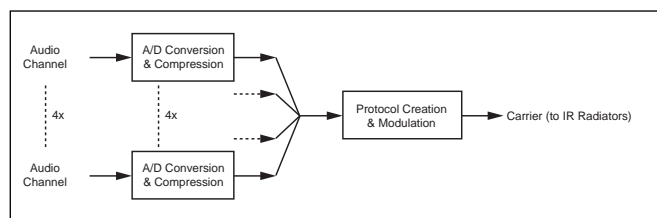

Figure 2.3 Overview of the signal processing (for one carrier)

2.2.3 Quality modes

The Integrus system can transmit audio in four different quality modes:

- Mono, standard quality, maximum 32 channels
- Mono, premium quality, maximum 16 channels
- Stereo, standard quality, maximum 16 channels
- Stereo, premium quality, maximum 8 channels

The standard quality mode uses less bandwidth and can be used for transmitting speech. For music the premium quality mode gives near CD quality.

2.2.4 Carriers and channels

The Integrus system can transmit up to 8 different carrier signals (depending on the transmitter type). Each carrier can contain up to 4 different audio channels. The maximum number of channels per carrier is dependent on the selected quality modes. Stereo signals use twice as much bandwidth as a mono signals, premium quality uses twice as much bandwidth as standard quality.

Per carrier a mix of channels with different quality modes is possible, as long as the total available bandwidth is not exceeded. The table below lists all possible channel combinations per carrier:

		Channel quality				Bandwidth
		Mono Standard	Mono Premium	Stereo Standard	Stereo Premium	
Possible number of channels per carrier	4					4 x 10 kHz
	2		1			2 x 10 kHz and 1 x 20 kHz
	2			1		2 x 10 kHz and 1 x 10 kHz (left) and 1 x 10 kHz (right)
			1	1		1 x 20 kHz and 1 x 10 kHz (left) and 1 x 10 kHz (right)
				2		2 x 10 kHz (left) and 2 x 10 kHz (right)
		2				2 x 20 kHz
					1	1 x 20 kHz (left) and 1 x 20 kHz (right)

2.3 Aspects of infra-red distribution systems

A good infra-red distribution system ensures that all delegates in a conference venue receive the distributed signals without disturbance. This is achieved by using enough radiators, placed at well planned positions, so that the conference venue is covered with uniform IR-radiation of adequate strength.

There are several aspects that influence the uniformity and quality of the infra-red signal, which must be considered when planning an infra-red radiation distribution system. These are discussed in the next sections.

2.3.1 Directional sensitivity of the receiver

The sensitivity of a receiver is at its best when it is aimed directly towards a radiator. The axis of maximum sensitivity is tilted upwards at an angle of 45 degrees (see figure 2.4). Rotating the receiver will decrease the sensitivity.

For rotations of less than +/- 45 degrees this effect is not large, but for larger rotations the sensitivity will decrease rapidly.

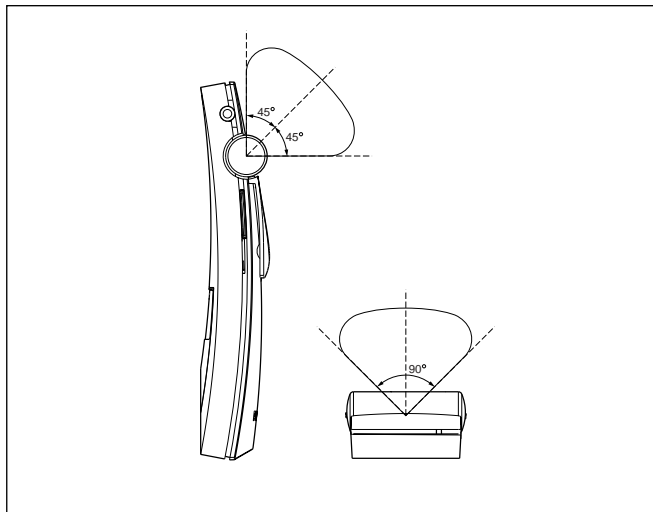

Figure 2.4 Directional characteristics of the receivers

2.3.2 The footprint of the radiator

The coverage area of a radiator depends on the number of transmitted carriers and the output power of the radiator. The coverage area of the LBB 4512 radiator is twice as large as the coverage area of the LBB 4511. The coverage area can also be doubled by mounting two radiators side by side. The total radiation energy of a radiator is distributed over the transmitted carriers. When more carriers are used, the coverage area gets proportionally smaller. The receiver requires a strength of the IR signal of 4 mW/m² per carrier to work without errors (resulting in a 80 dB S/N ratio for the audio channels). The effect of the number of carriers on the coverage area can be seen in figure 2.5 and figure 2.6. The radiation pattern is the area within which the radiation intensity is at least the minimum required signal strength.

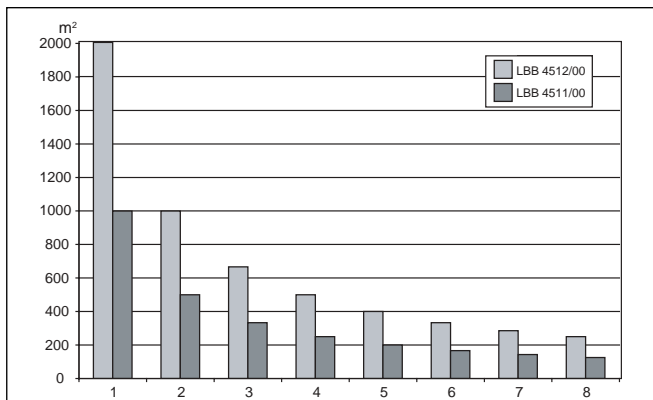

Figure 2.5 Total coverage area of LBB 4511/00 and LBB 4512/00 for 1 to 8 carriers

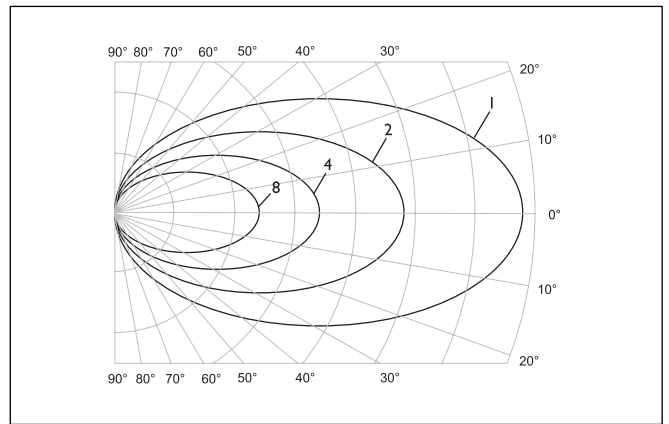

Figure 2.6 Polar diagram of the radiation pattern for 1, 2, 4 and 8 carriers

The cross section of the 3-dimensional radiation pattern with the floor of the conference venue is known as the footprint (the white area in figure 2.7 to figure 2.9). This is the floor area in which the direct signal is strong enough to ensure proper reception, when the receiver is directed towards the radiator. As shown, the size and position of the footprint depends on the mounting height and angle of the radiator.

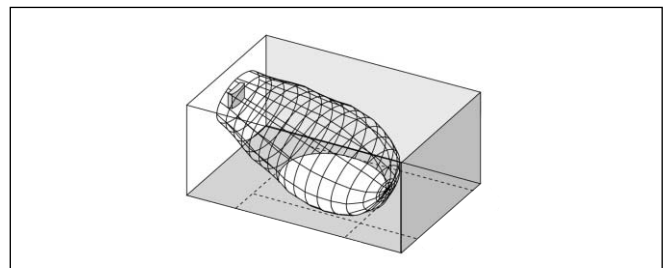

Figure 2.7 The radiator mounted at 15° to the ceiling

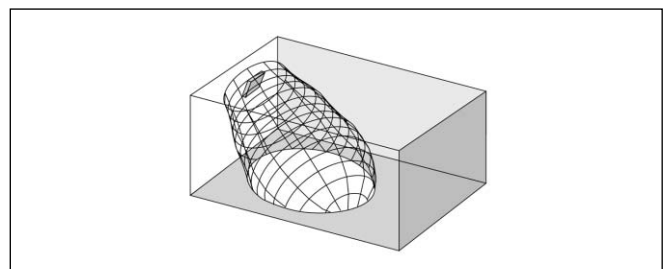

Figure 2.8 The radiator mounted at 45° to the ceiling

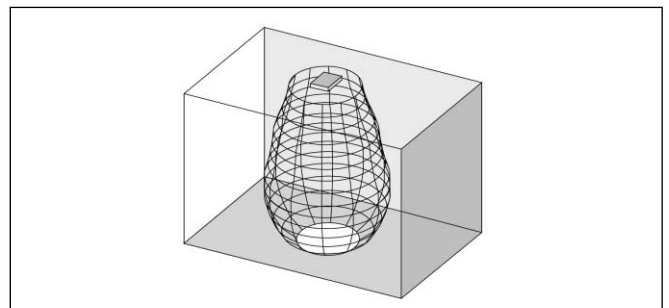

Figure 2.9 The radiator mounted perpendicular (at 90°) to the ceiling

2.3.3 Ambient lighting

The Integrus system is practically immune for the effect of ambient lighting. Fluorescent lamps (with or without electronic ballast or dimming facility), such as TL lamps or energy saving lamps give no problems with the Integrus system. Also sunlight and artificial lighting with incandescent or halogen lamps up to 1000 lux give no problems with the Integrus system. When high levels of artificial lighting with incandescent or halogen lamps, such as spotlights or stage lighting are applied, you should directly point a radiator at the receivers in order to ensure reliable transmission. For venues containing large, unscreened windows, you must plan on using additional radiators. For events taking place in the open air a site test will be required in order to determine the required amount of radiators. With sufficient radiators installed, the receivers will work without errors, even in bright sunlight.

2.3.4 Objects, surfaces and reflections

The presence of objects in a conference venue can influence the distribution of infra-red light. The texture and colour of the objects, walls and ceilings also plays an important role. Infra-red radiation is reflected from almost all surfaces. As is the case with visible light, smooth, bright or shiny surfaces reflect well. Dark or rough surfaces absorb large proportions of the infra-red signal (see figure 2.10). With few exceptions it cannot pass through materials that are opaque to visible light.

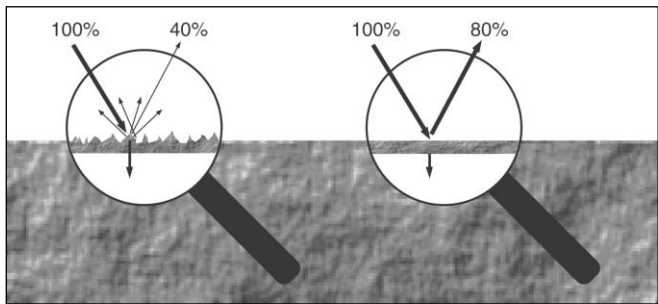

Figure 2.10 The texture of the material determines how much light is reflected and how much is absorbed

Problems caused by shadows from walls or furniture can be solved by ensuring that there are sufficient radiators and that they are well positioned, so that a strong enough infra-red field is produced over the whole conference area. Care should be taken not to direct radiators towards uncovered windows, as most of this radiation will subsequently be lost.

2.3.5 Positioning the radiators

Since infra-red radiation can reach a receiver directly and/or via diffused reflections, it is important to take this into account when considering the positioning of the radiators. Though it is best if receivers pick up direct path infra-red radiation, reflections improve the signal reception and should therefore not be minimised. Radiators should be positioned high enough not to be blocked by people in the hall (see figure 2.11 and figure 2.12).

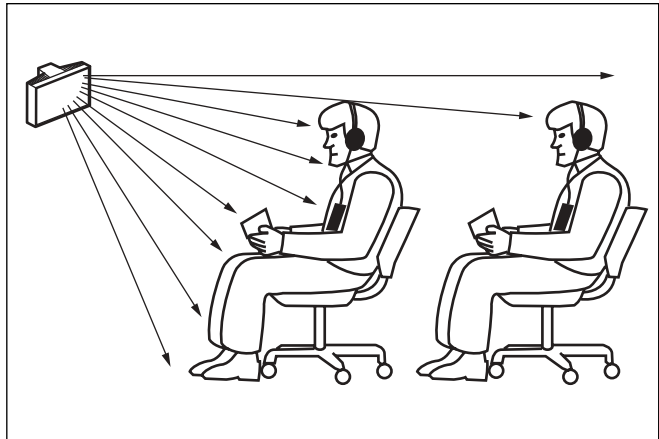

Figure 2.11 Infra-red signal blocked by a person in front of the participant

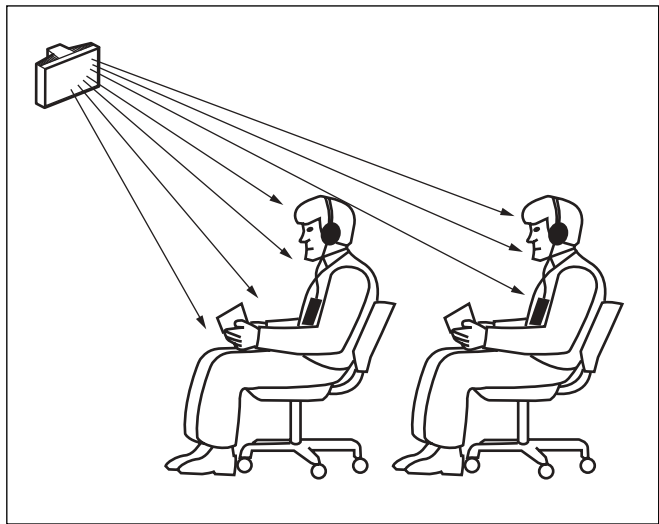

Figure 2.12 Infra-red signal not blocked by a person in front of the participant

The figures below illustrate how infra-red radiation can be directed to conference participants. In figure 2.14, the participant is situated clear from obstacles and walls, so a combination of direct and diffused radiation can be received. Figure 2.13 shows the signal being reflected from a number of surfaces to the participant.

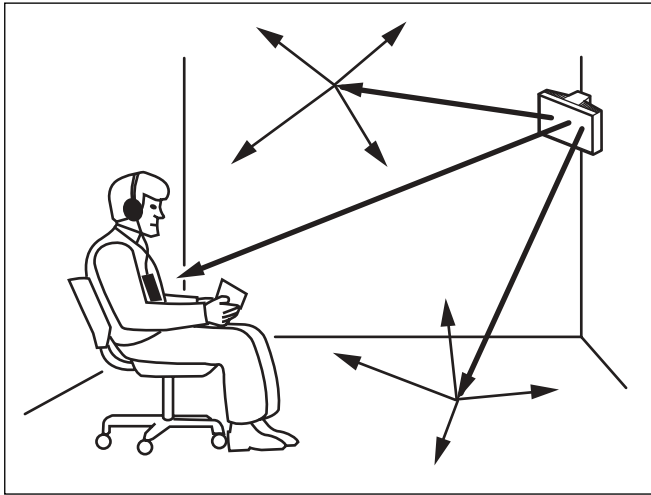

Figure 2.13 Combination of direct and reflected radiation

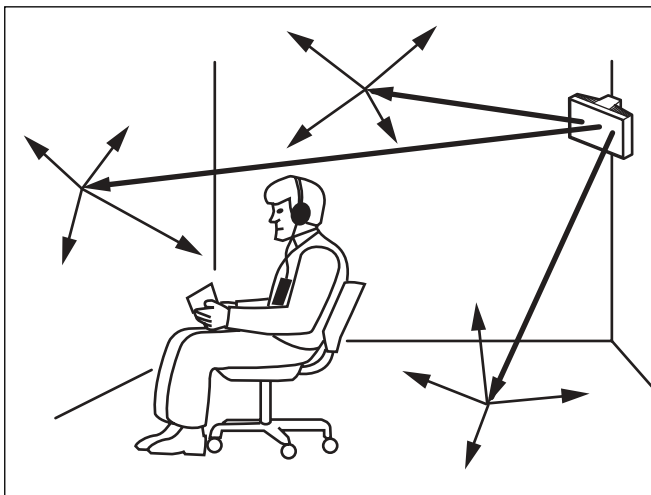

Figure 2.14 Combination of several reflected signals

For concentrically arranged conference rooms, centrally placed, angled radiators located high up can cover the area very efficiently. In rooms with few or no reflecting surfaces, such as a darkened film-projection room, the audience should be covered by direct path infra-red radiation from radiators positioned in front. When the direction of the receiver changes, e.g. with varying seat arrangements, mount the radiators in the corners of the room (see figure 2.15).

If the audience is always directed towards the radiators, you do not need radiators at the back (see figure 2.16). If the path of the infra-red signals is partially blocked, e.g. under balconies, you should cover the 'shaded' area with an additional radiator (see figure 2.17).

The figures below illustrate the positioning of the radiators:

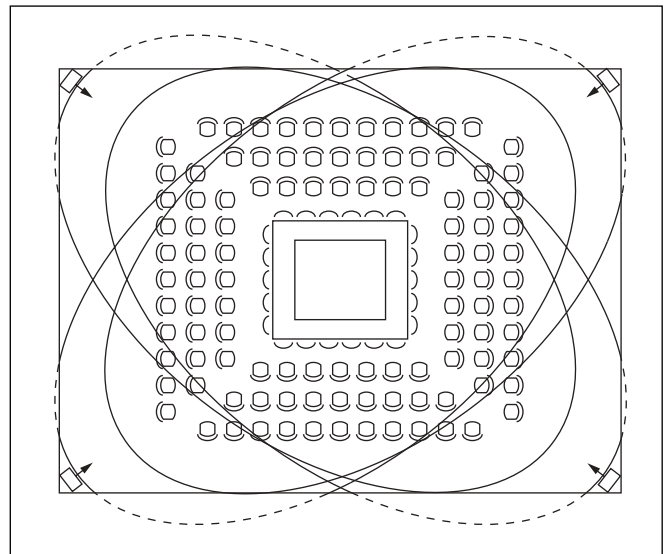

Figure 2.15 Radiator position for covering seats in a square arrangement

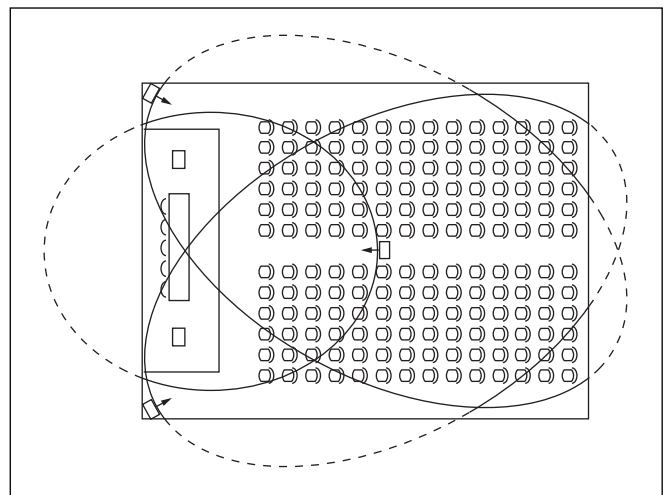

Figure 2.16 Radiator positioning in a conference hall with auditorium seating and podium

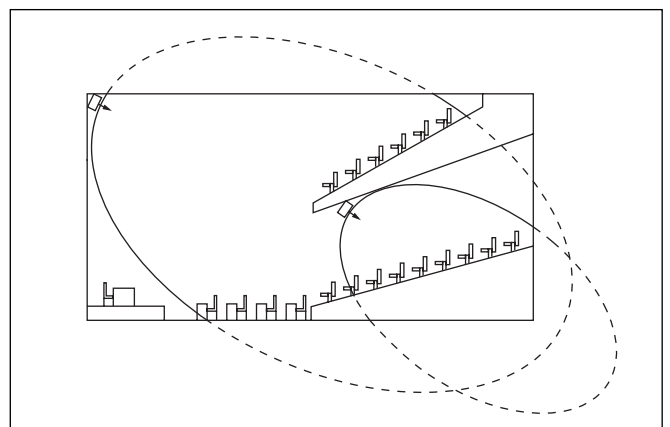

Figure 2.17 Radiator for covering seats beneath a balcony

2.3.6 Overlapping footprints and multipath effects

When the footprints of two radiators partly overlap, the total coverage area can be larger than the sum of the two separate footprints. In the overlap area the signal radiation power of two radiators are added, which increases the area where the radiation intensity is larger than the required intensity.

However, differences in the delays of the signals picked up by the receiver from two or more radiators can result in that the signals cancel each other out (multi path effect). In worst-case situations this can lead to a loss of reception at such positions (black spots).

Figure 2.18 and figure 2.19 illustrate the effect of overlapping footprints and differences in signal delays.

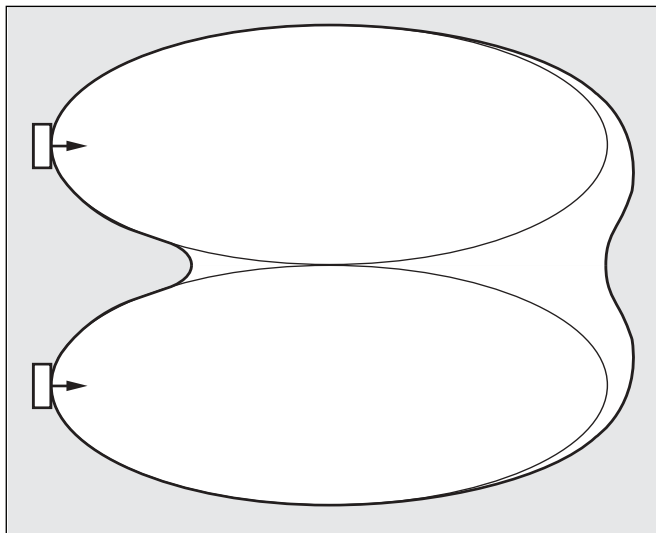

Figure 2.18 Increased coverage area caused by added radiation power

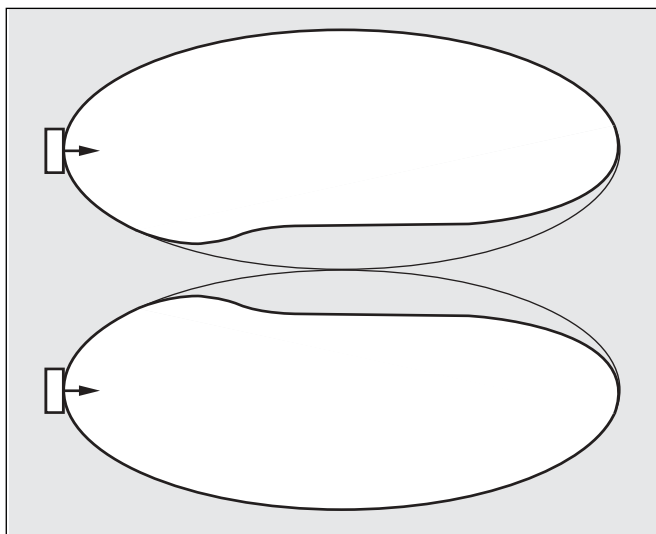

Figure 2.19 Reduced coverage area caused by differences in cable signal delay

The lower the carrier frequency, the less susceptible the receiver is for differences in signal delays.

The signal delays can be compensated by using the delay compensation switches on the radiators (see manual).

2.4 Planning an Integrus infra-red radiation system

2.4.1 Rectangular footprints

Determining the optimal number of infra-red radiators required to give 100% coverage of a hall can normally only be done by performing a site test. However, a good estimation can be made by using 'guaranteed rectangular footprints'. Figure 2.20 and figure 2.21 show what is meant by a rectangular footprint. As can be seen, the rectangular footprint is smaller than the total footprint. Note that in figure 2.21 the 'offset' X is negative because the radiator is actually mounted beyond the horizontal point at which the rectangular footprint starts.

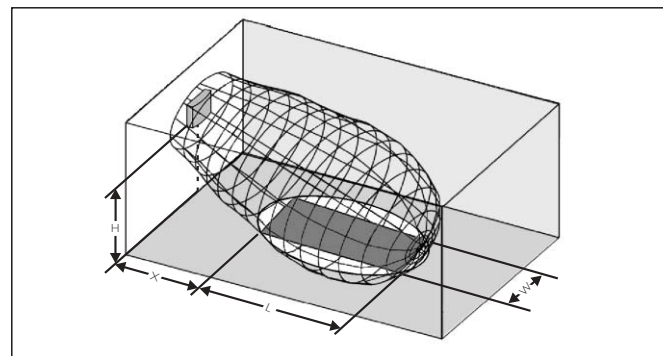

Figure 2.20 A typical rectangular footprint for a mounting angle of 15°

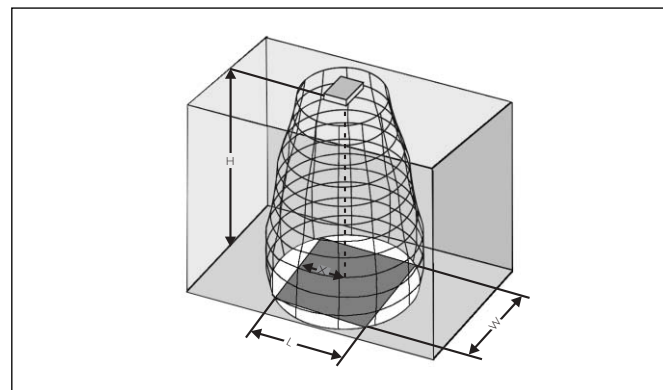

Figure 2.21 A typical rectangular footprint for a mounting angle of 90°

The guaranteed rectangular footprints for various number of carriers, mounting heights and mounting angles can be found in section 2.5. The height is the distance from the reception plane and not from the floor.

Guaranteed rectangular footprints can also be calculated with the footprint calculation tool (available on the documentation CD-ROM). The given values are for one radiator only, and therefore do not take into consideration the beneficial effects of overlapping footprints. The beneficial effects of reflections are also not included.

As rule of thumb can be given for systems with up to 4 carriers, that if the receiver can pick up the signal of two adjacent radiators the distance between these radiators can be increased by a factor 2.4 approximately (see figure 2.22).

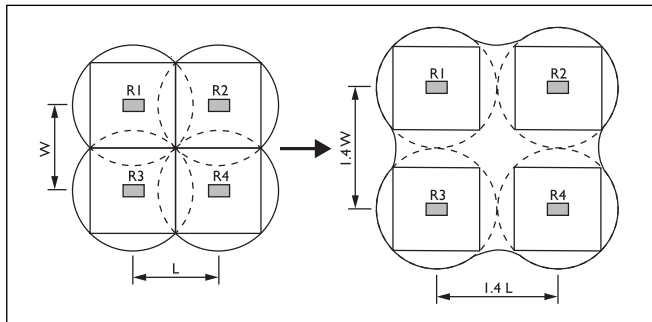

Figure 2.22 The effect of overlapping footprints

2.4.2 Planning radiators

Use the following procedure to plan the radiators:

- Follow the recommendations in section 2.3 in order to determine the positioning of the radiators
- Look up (in the table) or calculate (with the footprint calculation tool) the applicable rectangular footprints
- Draw the rectangular footprints in the lay-out of the room.
- If the receiver can pick up the signal of two adjacent radiators in some areas, determine the overlap effect and draw the footprint enlargement(s) in the lay-out of the room.
- Check whether you have sufficient coverage with the radiators at the intended positions.
- If not so, add additional radiators to the room.
- For larger systems and systems with more than 4 carriers, use the Ease-IR simulation program for optimising further the overlap effect and at the same time taking into account the multi path effect.

See figure 2.15, figure 2.16 and figure 2.17 for examples of a radiator lay out.

2.4.3 Cabling

Signal delay differences can occur due to differences in the cable length from the transmitter to each radiator. In order to minimize the risk of black spots, use equal cable length from transmitter to radiator if possible (see figure 2.23).

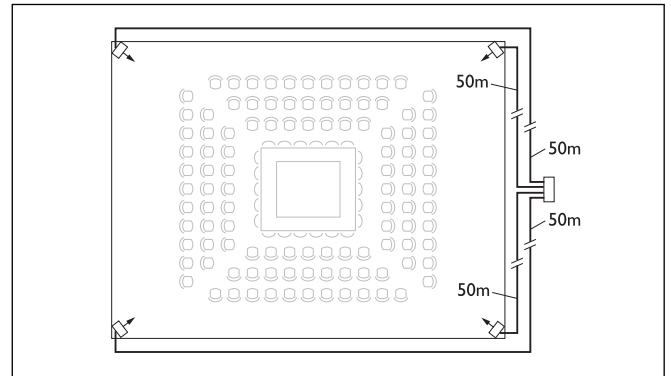

Figure 2.23 Radiators with equal cable length

When radiators are loop-through connected, the cabling between each radiator and the transmitter should be as symmetrical as possible (see figure 2.24 and figure 2.25). The differences in cable signal delays can be compensated with the signal delay compensation switches on the radiators.

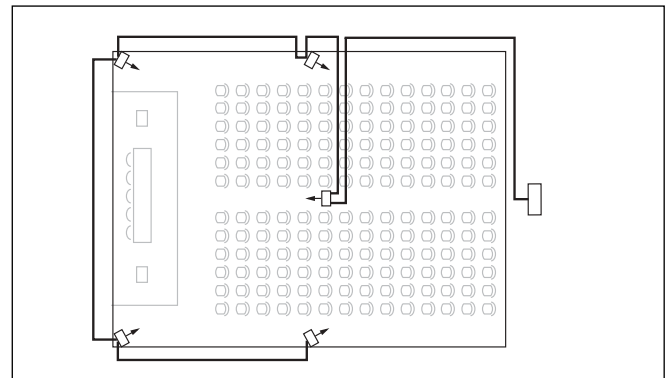

Figure 2.24 Asymmetrical arrangement of radiator cabling (to be avoided)

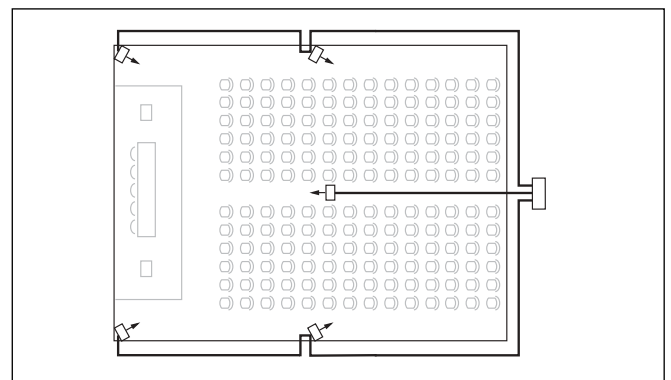

Figure 2.25 Symmetrical arrangement of radiator cabling (recommended)

2.5 Guaranteed rectangular footprints										
			LBB 4511/00 at full power				LBB 4512/00 at full power			
number of carriers	mounting height [m]	mounting angle [degrees]	area A [m ²]	length L [m]	width W [m]	offset X [m]	area A [m ²]	length L [m]	width W [m]	offset X [m]
1	2.5	0	627	33	19	7	1269	47	27	10
		15	620	31	20	7	1196	46	26	8
		30	468	26	18	4	816	34	24	6
		45	288	18	16	2	480	24	20	2
		60	196	14	14	0	324	18	18	0
	5	90	144	12	12	-6	196	14	14	-7
		15	589	31	19	9	1288	46	28	10
		30	551	29	19	5	988	38	26	6
		45	414	23	18	2	672	28	24	2
		60	306	18	17	-1	506	23	22	-1
	10	90	256	16	16	-8	400	20	20	-10
		30	408	24	17	13	1080	40	27	11
		45	368	23	16	7	945	35	27	4
		60	418	22	19	1	754	29	26	-1
		90	324	18	18	-9	676	26	26	-13
2	2.5	15	308	22	14	4	576	32	18	6
		15	322	23	14	5	620	31	20	7
		30	247	19	13	3	468	26	18	4
		45	168	14	12	1	288	18	16	2
		60	132	12	11	-1	196	14	14	0
	5	90	100	10	10	-5	144	12	12	-6
		30	266	19	14	6	551	29	19	5
		45	234	18	13	2	414	23	18	2
		60	195	15	13	-1	306	18	17	-1
		90	144	12	12	-6	256	16	16	-8
	20	60	195	15	13	3	418	22	19	1
		90	196	14	14	-7	324	18	18	-9
4	2.5	15	160	16	10	3	308	22	14	4
		15	144	16	9	4	322	23	14	5
		30	140	14	10	3	247	19	13	3
		45	99	11	9	1	168	14	12	1
		60	90	10	9	-1	132	12	11	-1
	5	90	64	8	8	-4	100	10	10	-5
		45	120	12	10	3	234	18	13	2
		60	108	12	9	0	195	15	13	-1
		90	100	10	10	-5	144	12	12	-6
		90	64	8	8	-4	196	14	14	-7
8	2.5	15	84	12	7	2	160	16	10	3
		15	60	10	6	4	144	16	9	4
		30	70	10	7	3	140	14	10	3
		45	63	9	7	1	99	11	9	1
		60	49	7	7	0	90	10	9	-1
	5	90	36	6	6	-3	64	8	8	-4
		60	49	7	7	2	108	12	9	0
		90	49	7	7	-3.5	100	10	10	-5

(The mounting height is the distance from the reception plane and not from the floor.)

3. System Specification

3.1 Features and Benefits:

- Conforms to IEC 60914, the international standard for conference systems
- Conforms to IEC 61603 part 7, the international standard for digital infra-red transmission of audio signals for conference and similar applications
- Up to 32 digital audio channels
- Wireless transmission gives participants freedom of movement
- Conference hall privacy; the congress venue itself acts as a barrier to infra-red signals escaping and being overheard, as infra-red is unable to pass through opaque structures such as walls
- No interference between separate conference rooms, making it possible to use an unlimited number of systems in adjacent rooms
- Transmission in 2-8 MHz frequency band, which eliminates disturbance from all types of lighting systems
- Digitised audio ensures very high audio quality
- Powerful compression techniques enable efficient, low-loss transmission
- Comprehensive error correction ensures error-free transmission
- Synchronization with the number of channels in use means the user does not have to scroll through unused channels
- Quality levels are programmable per channel, giving maximum flexibility for optimising transmission:
- Mono standard quality mode for efficient distribution of languages
- Stereo standard quality mode for efficient distribution of music
- Premium quality modes for distribution of very high quality sound

3.2 Transmission Characteristics

IR transmission wavelength	: 870 nm
Modulation frequency	: Carriers 0 to 5; 2 to 6 MHz, according to IEC 60603 part 7
	: Carriers 6 and 7; up to 8 MHz
Protocol and modulation technique	: DQPSK, according to IEC 60603 part 7

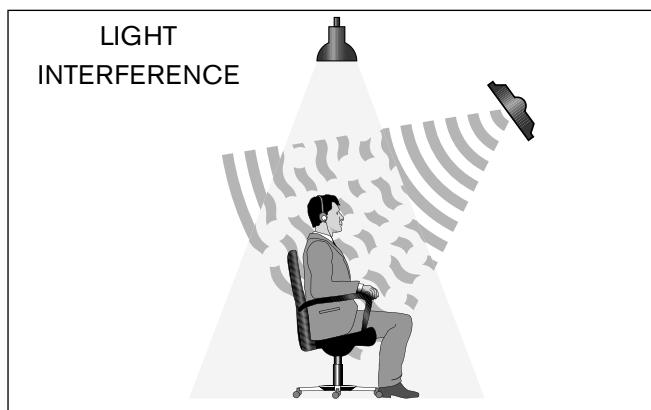

DISTORTED RECEPTION OTHER LANGUAGE DISTRIBUTION SYSTEMS

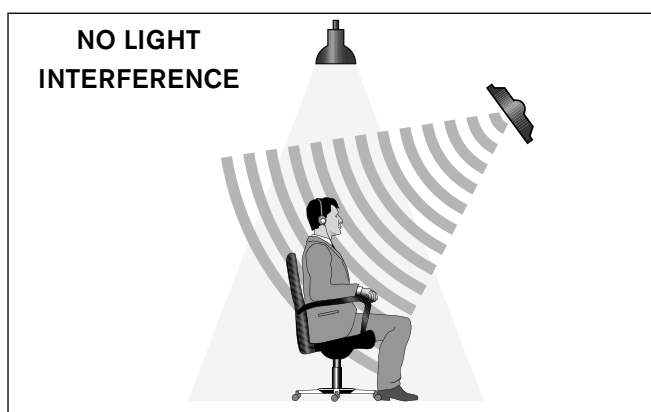

PERFECT RECEPTION NEW BOSCH INTEGRUS SYSTEM

3.3 System Audio Performance

Measured from the audio input of an LBB 4502 transmitter to the headphone output of an LBB 4540 receiver

Audio frequency response	: 20 Hz to 10 kHz (-3 dB)
	at Standard Quality
	20 Hz to 20 kHz (-3 dB)
	at Premium Quality

Total harmonic distortion	
at 1 kHz	: < 0.05 %

Crosstalk attenuation at 1 kHz : > 80 dB

Dynamic range : > 80 dB

Weighted signal-to-noise ratio : > 80 dB(A)

3.4 Cabling and System Limits

Cable type	: 75 Ohm RG59
Maximum number of radiators	: 30 per HF output
Maximum cable length	: 900 m per HF output

3.5 System Environmental Conditions

Working conditions	: Fixed/stationary/transportable
Temperature range	
- transport	: -40 to + 70 °C (-40 to 158 °F)
- operating	: +5 to + 45 °C (41 to 113 °F)
	+5 to +35 °C (41 to 122 °F)
	for LBB 4560
	+5 to + 55 °C (41 to 131 °F)
	for LBB 4502
Maximum relative humidity	: < 93%
Safety	: According to EN 60065, CAN/ CSA-E65 (Canada and US) and UL 6500
	: According to EN 60065, CAN/ CSA-E65 (Canada and US) and UL 1419 for LBB 4511/00 and LBB 4512/00
EMC emission	: According to harmonized standard EN 55103-1 and FCC rules part 15, complying with the limits for a class A digital devices
EMC immunity	: According to harmonized standard EN 55103-2
EMC approvals	: Affixed with the CE mark.
ESD	: According to harmonized standard EN 55103-2
Mains harmonics	: According to harmonized standard EN 55103-1
Environmental requirements	: Contains no banned substances as specified in UAT-0480/100 (e.g. no cadmium or asbestos)

4. Transmitter and Modules

4.1 LBB 4502 Transmitter

The transmitter is the central element in the Integrus system. It accepts analogue or digital input (from DCN), modulates these signals onto carrier waves and transmits these carrier waves to radiators located in the room.

Product Variants:

- LBB 4502/04: 4-Channel Transmitter
- LBB 4502/08: 8-Channel Transmitter
- LBB 4502/16: 16-Channel Transmitter
- LBB 4502/32: 32-Channel Transmitter

4.1.1 Features and Benefits

- Universal mains power facility allows use worldwide
- Capable of distributing a maximum of 4, 8, 16 or 32 audio channels
- Can be used with DCN or analogue systems like the CCS 800
- Automatic distribution of emergency messages to all channels
- Auxiliary mode for distribution of music to all channels during a break
- Flexible configuration of channels and channel quality modes for efficient distribution
- Adjustable sensitivity for each input to enable fine tuning of audio levels
- Test mode which produces a different frequency tone for each input/channel, with the tone gradually rising as the channels are stepped through.
- Slave mode for distribution of signals from another transmitter allows multiple rooms to be used
- Built-in mini infra-red radiator for audio monitoring
- Radiator and system status indication via display
- Configuration of transmitter and system via a display and one single rotary push button
- Each transmitter can be assigned a unique name by the installer for easy identification in a multi-transmitter system
- Each audio channel can also be assigned a unique name by the installer. These names can be selected from a list of options or entered manually.
- Automatic standby/on function
- Automatic synchronization to the number of channels in use in a DCN system
- Stylish 19" (2U) housing for table top use or rack mounting



- Handgrips for easy transportation
- 19" rack mounting brackets, detachable feet and mounting accessories for modules included
- System installation and operating manual on CD-ROM
- Mains cable included

4.1.2 Controls and Indicators

- 2 x 16 character LCD display for status information and transmitter configuration
- Rotary push button for navigation through menus and configuration
- Power on/off switch on front panel

4.1.3 Interconnection

- Male Euro socket for mains connection
- Slot with audio data bus connector (H 15, female) for accepting LBB 3422/10 Symmetrical Audio Input and Interpreters Module or LBB 3423/00 DCN Interface Module
- 4, 8, 16 or 32 cinch connectors for input of asymmetrical audio signals
- Two XLR sockets for input of symmetrical signals of floor, emergency messages or music
- One terminal block socket for distribution of emergency messages to all channels

- 3.5 mm stereo headphone socket for monitoring inputs and channels
- One BNC connector for accepting an HF signal from another transmitter
- Four BNC connectors for output of HF signal to up to 30 radiators

4.1.4 Physical Characteristics

Mounting	: Brackets for 19" rack mounting or fixing to a table top
	: Detachable feet for free-standing use on a table top
Dimensions (H x W x D)	: 88 x 483 x 350 mm (35 x 190 x 138 in) for 19" rack use, with brackets, without feet
	: 92 x 440 x 350 mm (36 x 190 x 138 in) for table top use, without brackets, with feet
Weight	: 6.7 kg (14.7 lbs) with brackets, without feet
	: 6.8 kg (15.0 lbs) without brackets, with feet
Finish	: Charcoal with silver

4.1.5 Electrical Characteristics

Asymmetrical audio inputs	: -6 to +6 dBV nominal
Symmetrical audio inputs	: +6 to +18 dBV nominal
Emergency switch connector	: emergency control input
Headphone output	: 32 Ohm to 2 kOhm
HF input	: nominal 1Vpp, minimum 10 mVpp, 75 Ohm
HF output	: 1 Vpp, 6 VDC, 75 Ohm
Mains voltage	: 90 to 260 V, 50 to 60 Hz
Power consumption	: maximal 55 W
Power consumption (standby)	: 29 W

4.2 LBB 3423/00 DCN Interface Module

The DCN Interface Module is used for interfacing the transmitter with the DCN system. The floor and interpretations generated by the DCN system can then be distributed to conference participants via the Integrus system.



4.2.1 Features and Benefits

- Automatically switches on LBB 4502 Transmitter when the DCN system is switched on
- Automatic synchronization to the number of channels in use in the DCN system

4.2.2 Controls and Indicators

- DCN supply voltage presence indicated on the display of LBB 4502 Transmitter

4.2.3 Interconnection

- DCN trunk input cable 2 m (6 ft 6 in) with 6-pole DIN male connector
- DCN trunk output; 6-pole female DIN female connector for loop-through connection
- Audio and data bus connector; H 15 male connector

4.2.4 Physical Characteristics

Mounting	: Front panel is removed when use with LBB 4502 Transmitter
Dimensions (H x W x D)	: 100 x 26 x 231 mm (39 x 10 x 91 in) without front panel
Weight	: 312 g (0.69 lb) without front panel

4.2.5 Electrical Characteristics

- See DCN data brochure.

4.3. LBB 3422/10 Symmetrical Audio Input and Interpreters Module

The Symmetrical Audio Input and Interpreters Module is used for interfacing the transmitter with the CCS 800 discussion systems and the LBB 3422/04 6-Channel Interpreter Desk with Loudspeaker. Different connections and switch settings are possible to also allow the module to be used with non-Bosch systems.

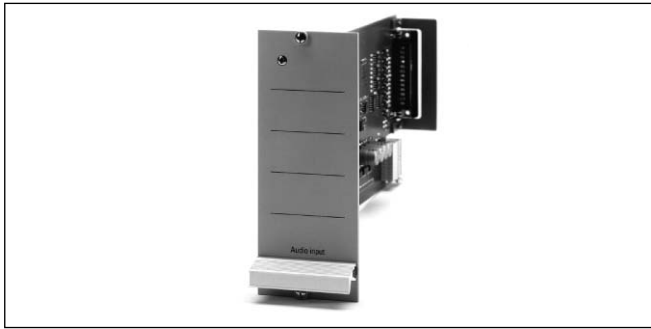

4.3.1 Features and Benefits

- Direct connection of up to 12 LBB 3222/04 Interpreter Desks for six languages
- Routing of floor signal (for instance from a CCS 800 discussion system) to interpreter desks
- Eight symmetrical inputs
- Facility for mounting input transformers for galvanic isolation between audio source and the transmitter

4.3.2 Controls and Indicators

- On-board switches can be set for directly connecting interpreter desks (LBB 3222/04) or other audio sources
- An on-board switch can be used to match the amplification of floor signals from CCS 800 or from other analogue conference systems
- An on-board switch can be used to replace the interpretation signal with the floor signal for distribution to the listeners when an interpreter channel is not in use

4.3.3 Interconnection

- Symmetrical analogue audio input; 25-pole female sub-D connector
- Audio and data bus connector; H 15 male connector

4.3.4 Physical Characteristics

Mounting	: Front panel is removed when use with LBB 4502 Transmitter
Dimensions (H x W x D)	: 100 x 26 x 231 mm (39 x 10 x 91 in) without front panel
Weight	: 132 g (0.29 lb) without front panel

4.3.5 Electrical Characteristics

Audio input level with AGC	: -16.5 dBV (150 mVeff) to +3.5 dBV (1500 mVeff)
Audio input level without AGC	: -4.4 dBV (600 mVeff)
Asymmetric input impedance	: ≥ 10 kOhm
DC input impedance	: ≥ 200 kOhm

5. Radiators and Accessories

5.1 LBB 4511/00 and LBB 4512/00 Radiators

These radiators are used to distribute infra-red signals throughout the conference venue, enabling delegates to listen to the proceedings by means of personal receivers.

Product Variants:

- LBB 4511/00: Medium-Power Radiator
- LBB 4512/00: High-Power Radiator

5.1.1 Features and Benefits

- LBB 4511 covers up to 1000 m² (one carrier, 4 standard quality channels)
- LBB 4512 covers up to 2000 m² (one carrier, 4 standard quality channels)
- Power output selection for efficiency and economy
- Universal mains power facility allows use worldwide
- No fan - cooled by convection - resulting in quieter operation and less moving parts to wear out
- LED indicators for radiator status checking
- Communication between radiator and transmitter for easy checking by the operator
- Automatically switches on when transmitter is switched on and vice versa
- Automatic gain control ensures the IREDS (infra-red emitting diodes) function with maximum efficiency
- Automatic cable equalization ensures maximum transmission efficiency with different quality of cables
- Automatic cable termination simplifies installation
- Temperature protection circuitry automatically switches radiator from full- to half- power if the temperature becomes too high
- Brackets for mounting on ceiling and floor stand included, which simplifies installation
- Adjustable radiator angle ensures maximum coverage
- IREDS protected by a cover plate, making the units easy to maintain and clean
- Attractive and stylish design
- Mains cable included

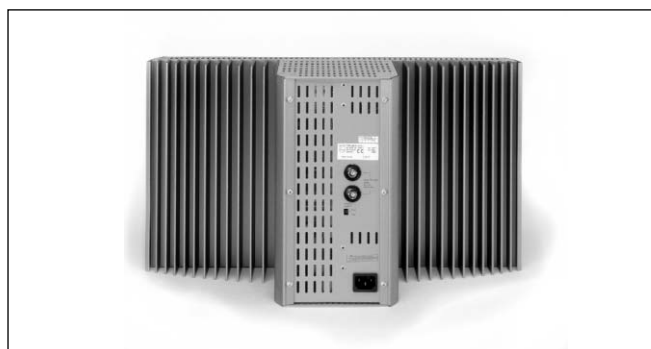

5.1.2 Controls and Indicators

- Two yellow LEDs: one on each radiator panel to indicate that this panel is switched on and is receiving carrier waves from the transmitter
- Two red LEDs: one on each radiator panel to indicate that this panel is in standby mode
- Red and yellow LEDs simultaneously illuminated to indicate the radiator panel is malfunctioning
- Red LED flashing and yellow LEDs to indicate the radiator panel is in temperature protection mode
- Power reduction switch to reduce the output of the radiator to half-power
- Two delay compensation switches to compensate for differences in cable lengths between transmitter and radiators

5.1.3 Interconnection

- Male Euro socket for mains connection
- HF input and output connectors (2 x BNC) for connection to transmitter and loop-through to other radiators

5.1.4 Physical Characteristics

Mounting	: Suspension bracket for direct ceiling mounting
	: Mounting plates for floor stands with M10 and 1/2"Whitworth thread
	: LBB 3414/00 Wall Mounting Bracket can be used for fixing radiator to wall surfaces
Dimensions (H x W x D)	: LBB 4511/00 without bracket: 200 x 500 x 175mm (7.9 x 19.7 x 6.9 in)
	: LBB 4512/00 without bracket: 300 x 500 x 175mm (11.0 x 19.7 x 6.9 in)
Radiator angle	: 0, 15 and 30° for floor-stand mounting
	: 0, 15, 30, 45, 60, 75 and 90° for wall/ceiling mounting.
Weight	: LBB 4511/00 without bracket: 6.8 kg (15 lbs)
	: LBB 4511/00 with bracket: 7.6 kg (17 lbs)
	: LBB 4512/00 without bracket: 9.5 kg (21 lbs)
	: LBB 4512/00 with bracket: 10.3 kg (23 lbs)
Finish	: Bronze coloured

5.1.5 Electrical and Optical Characteristics

Number of IREDS	: 260 (LBB 4511/00), 480 (LBB 4512/00)
Total IR output at 20 °C	: 8 Wrms 16 Wpp (LBB 4511/00), 16 Wrms 32 Wpp (LBB 4512/00)
Total optical peak intensity	: 9 W/sr (LBB 4511/00), 18 W/sr (LBB 4512/00)
Angle of half intensity	: +/- 22°
HF input	: nominal 1Vpp, minimal 10 mVpp
HF output	: 1 Vpp, 6 VDC, 75 Ohm
Mains voltage	: 90 to 260 V, 50 to 60 Hz
Power consumption	: 100 W (LBB 4511/00), 180 W (LBB 4512/00)
Power consumption (standby)	: 8 W (LBB 4511/00), 10 W (LBB 4512/00)

5.2 LBB 3414/00 Wall Mounting Bracket

Bracket for wall mounting the LBB 4511/00 and LBB 4512/00 Radiators.



Physical characteristics:

Dimensions (H x W x D)	: 200 x 280 x 160mm (7.9 x 11.0 x 6.3 in)
Weight	: 1.8 kg (4.0 lb)
Finish	: Quartz grey

5.3 Radiator Suitcase (Audipack)

Storage suitcases for LBB 4511/00 and LBB 4512/00 Radiators are available from Audipack respectively the 13891 and 13892.

Physical characteristics:

Dimensions (H x W x D)	: Audipack 13891: 250 x 540 x 300 mm (10 x 21 x 12 in)
	: Audipack 13892: 250 x 540 x 400 mm (10 x 21 x 16 in)
Weight	: Audipack 13891: 6.5 kg (14 lbs) : Audipack 13892: 7.0 kg (15 lbs)
Finish	: Grey



6. Receivers, Battery Packs and Charging Units

6.1 LBB 4540 Pocket Receivers

These ergonomically designed receivers incorporate the latest electronics technology - including a specially designed IC - to ensure maximum performance and a long battery lifetime. The receivers can be used for both language and music distribution.

Product variants:

- LBB 4540/04: 4-Channel Pocket Receiver
- LBB 4540/32: 32-Channel Pocket Receiver

6.1.1 Features and Benefits

- Specially-designed IC for maximum performance and a long battery life time
- Recharging electronics integrated in the chip, ensuring optimum charging performance
- 2-digit LCD display with battery and reception status indication
- Number of available channels is always the same as the number of channels in use by the system, eliminating the need to scroll through unused channels
- Audio signal automatically muted when signal is too low, ensuring that the user receives only high quality audio
- Can be used with disposable batteries (2x AA alkaline batteries) or environmentally-friendly NiMH rechargeable battery pack (LBB 4550/00)
- No power used when headphone is disconnected
- Clip for easy wearing
- Measurement mode for easy checking of radiator coverage
- Attractive and stylish design
- Up to 200 hours operation with alkaline batteries
- Up to 75 hours operation with battery pack
- Recharges from empty to full capacity within 1 hour and 45 minutes

6.1.2 Controls and Indicators

- 2-digit LCD display with channel number, battery and reception status indication
- On/off button
- Volume control slide adjuster
- Channel selection up/down buttons
- Charging indicator LED



6.1.3 Interconnection

- 3.5 mm (0.14 in) stereo jack output socket for headphones
- Battery contacts for use with AA alkaline batteries
- Connector for use with LBB 4550 battery packs
- Charging contacts on the left-hand side of the receiver for compatibility with LBB 4560 charging units*

6.1.4 Physical Characteristics

Dimensions (H x W x D)	: 155 x 45 x 30 mm (6.1 x 1.8 x 1.2 in)
Weight excl. batteries/ battery pack	: 75 g (0.16 lb)
Weight incl. battery pack	: 125 g (27 lb)
Finish	: Charcoal with silver

6.1.5 Electrical and Optical Characteristics

IR irradiance level	: 4 mW/m ² per carrier
Angle of half sensitivity	: +/-50 °
Headphone output level at 2.4V	: 450 mVrms (speech at maximum volume, 32 Ohm headphone)
Headphone output frequency range	: 20 Hz to 20 kHz
Headphone output impedance	: 32 Ohm to 2 kOhm
Max. signal-to-noise ratio	: 80 dB(A)
Supply voltage	: 1.8 to 3.6 V, nominal 2.4 V
Power consumption at 2.4 V	: 15 mA (speech at maximum volume, 32 Ohm headphone)
Power consumption (standby)	: < 1 mA

* LBB 3406, 3407, 3408 and 3409 charging units are electronically incompatible with LBB 4540 Pocket Receivers, and can actually damage them. That is why the charging contacts on LBB 4540 Pocket Receivers and LBB 4560 Charging Units have deliberately been located on the left-hand side, which is a different position than found on the mentioned charging units.

6.2 LBB 4550/00 NiMH Battery Pack

NiMH battery pack for use with LBB 4540 Pocket Receiver



Features:

- Temperature sensor for optimal charging process

Physical characteristics:

Dimensions (H x W x D) : 14 x 28 x 49 mm (5.5 x 11 x 19 in)

Weight : 50 g (11 lb)

Electrical characteristics:

Voltage : 2.4 V

Capacity : 1100 mAh

6.3 LBB 4560 Charging Units

The charging units are used for charging and storing the LBB 4540 Pocket Receivers

Product Variants:

- LBB 4560/00: Charging Suitcase
- LBB 4560/50: Charging Cabinet



6.3.1 Features and Benefits

- Can accommodate 56 receivers
- Universal mains power facility allows use worldwide
- Mains input with loop-through facilities
- Rapid recharging: maximum time required; 1 hour and 45 minutes
- Mains cable included

6.3.2 Controls and Indicators

- On/off switch
- Charging status indication on the receivers

6.3.3 Interconnection

- Mains input with loop-through facility; male and female Euro mains socket
- 56 charging contacts. Compatible with LBB 4540 receivers*

6.3.4 Physical Characteristics

Mounting : LBB 4560/50: screws and plugs for wall mounting included

Dimensions (H x W x D) : LBB 4560/00: 230 x 690 x 530 mm (9 x 27 x 21 in)

: LBB 4560/50: 130 x 680 x 520 mm (5 x 27 x 20 in)

Weight excl. receivers : LBB 4560/00: 15.5 kg (34 lbs)

: LBB 4560/50: 11.2 kg (25 lbs)

Weight incl. 56 receivers : LBB 4560/00: 22.3 kg (49 lbs)

: LBB 4560/50: 18.0 kg (40 lbs)

Finish : Charcoal with grey

6.3.5 Electrical Characteristics

Mains voltage : 90 to 260 V, 50 to 60 Hz

Power consumption : 270 W (56 receivers charging)

Power consumption (standby) : 17 W (no receivers in the charging unit)

6.4 Storage Suitcase

A storage suitcase for 100 LBB 4540 Pocket Receivers is available from Audipack, the 6402.

Physical characteristics:

Dimensions (H x W x D) : 207 x 690 x 530 mm (8 x 27 x 21 in)

Weight : 7.5 kg (16.5 lbs)

Finish : Grey

* LBB 3406, 3407, 3408 and 3409 charging units are electronically incompatible with LBB 4540 Pocket Receivers, and can actually damage them. That is why the charging contacts on LBB 4540 Pocket Receivers and LBB 4560 Charging Units have deliberately been located on the left-hand side, which is a different position than found on the mentioned charging units

7. Headphones

A range of headphones is available for use with LBB 4540 Pocket Receivers. This range includes Lightweight Stereo Headphones (LBB 3443/00), Stethoscopic Headphones (LBB 3441/00), Single Earphones (LBB 3442/00) and High-Quality Dynamic Headphones (LBB 3015/04).

7.1 LBB 3443/00 Lightweight Stereo Headphones

Physical and Electrical Characteristics:

Connection	: 1.3 m (4 ft) cable with 3.5 mm (0.14 in) jack plug
Impedance	: 32 Ohm
Audio frequency response	: 50 Hz to 20 kHz (-10 dB)
Power handling capacity	: 50 mW
Sensitivity (1 kHz)	: 98 dB SPL/earpiece at 1 mW/earpiece
Weight	: 70 g (0.16 lb)
Finish	: Charcoal with silver



Set of 100 pairs of replacement ear pads: LBB 3443/50

7.2 LBB 3441/00 Under The Chin Headphones

Physical and Electrical Characteristics:

Connection	: 1.2 m (4 ft) cable with 3.5 mm (0.14 in) jack plug
Impedance	: 300 Ohm
Audio frequency response	: 50 Hz to 5 kHz (-10 dB)
Power handling capacity	: 60 mW
Sensitivity (1 kHz)	: 107 dB SPL/earpiece at 1 mW/earpiece
Weight	: 33 g (0.07 lb)
Finish	: Black



Set of 1000 replacement ear tips: LBB 3441/50

7.3 LBB 3442/00 Single Earphone

Physical and Electrical Characteristics:

Connection	: 1.2 m (4 ft) cable with 3.5 mm (0.14 in) jack plug
Impedance	: 32 Ohm
Audio frequency response	: 100 Hz to 5 kHz (-10 dB)
Power handling capacity	: 5 mW
Sensitivity (1 kHz)	: 114 dB SPL at 1 mW/earpiece
Weight	: 25 g (0.06 lb)
Finish	: Dark grey



7.4 LBB 3015/04 High Quality Dynamic Headphones

Physical and Electrical Characteristics:

Connection : 1.2 m (4 ft) cable with 3.5 mm
(0.14 in) jack plug

Impedance : 360 Ohm

Audio frequency response : 250 Hz to 13 kHz (-10 dB)

Power handling capacity : 200 mW

Sensitivity (1 kHz) : 96 dB SPL/earpiece
at 1 mW/earpiece

Weight : 90 g (0.20 lb)

Finish : Black/grey



Single pair of replacement ear pads:
ordering code 8222 231 16451

8. 6-Channel Interpreter Desk and Accessories

8.1. LBB 3222/04 6-Channel Interpreter Desk with Loudspeaker

The LBB 3222/04 is a single-user, microprocessor-controlled interpreter desk, which offers an economical solution for providing interpretations to conference participants. The LBB 3222/04 interfaces with the transmitter via the LBB 3422/10 Symmetrical Audio Input and Interpreters Module. The floor signal is routed from the transmitter to the interpreter desks.

8.1.1 Features and Benefits

- Built-in loudspeaker
- Accommodates 6 different language channels plus the original floor language
- 12 interpreter desks can be loop-through connected within and/or between interpreter booths
- Up to three interpreter desks can be present per booth
- Incoming channel pre-selector key eliminates the need to manually search through all available language channels
- Quick switching between the floor language and the channel set on the channel selector reduces the chance of operator errors
- Electronic channel interlock function prevents interpreters in different booths from using the same output channel
- Auto relay enable function allows the interpreter to provide the auto relay language (OR2) for relay interpretation
- The channel B disable function allows the interpreter to disable channel B while ensuring that the desk remains connected to channel A

8.1.2 Controls and Indicators

- Microphone mounted on a flexible stem, complete with a light ring which illuminates when the microphone is on
- Headphone volume, treble and bass controls
- A-B channel selector key with channel select indicators
- Six outgoing B-channel select keys with channel select indicators
- Outgoing 'OR2' (auto relay) indicator
- 'Channel engaged' indicators to show which channels are in use by other interpreters
- Microphone 'mute' key
- Microphone activating key with LED status indicator
- Select key with LED indicators for fast switching



- between the original floor language and the channel set on the channel selector
- Incoming channel 'OR2' (auto relay) indicator to show that the original floor language has been replaced by a transfer interpretation channel, when the auto-relay facility is in operation
- Incoming language channel selector for headphone monitoring
- Call key (voice) to provide two-way communication between interpreter and chairman/operator
- Outgoing message key
- Incoming message indicator
- Rotary switch to preset the outgoing channel via the A output

8.1.3 Interconnections

- 3 m cable terminated with a 25-pin sub D-type connector
- 25-pin sub D-type socket for loop-through connections
- 6.3 mm (0.25 in) stereo jack headphone connectors
- 15-pole 180° DIN-type socket for connection of interpreter's headset with microphone, plus switch to mute the built-in microphone
- Auxiliary socket (message) for the desk's message function

8.1.4 Physical Characteristics

Mounting	: Table top or flush mounting
Dimensions	: 20-58 x 250 x 189 mm (0.79–2.28 x 9.84 x 7.44 in) (H[front]–H[rear] x W x D)
Weight	: 1.75 kg (3.85 lb)
Finish	: Light grey

8.1.5 Electrical Characteristics

Frequency response : 125 Hz (-10 dB) to 12.5 kHz (-2 dB)

Rated equivalent sound

pressure due

to inherent noise : < 32 dB

Total harmonic distortion

at overload : < 5%

Crosstalk attenuation : > 66 dB

8.2 LBB 9095/30 Interpreter Headphones

Lightweight, dynamic headphones for direct connection to LBB 3222/04 Interpreter Desk

Physical and electrical characteristics:

Connection : 1.5 m (59.05 in) cable with 6.3 mm (0.25 in) jack plug

Impedance : 2 x 720 Ohm

Frequency response : 250 Hz to 13 kHz (-10 dB)

Power handling capacity : 200 mW

Sensitivity (1 kHz) : 97 dB SPL/earpiece
at 0 dBV/system

: 96 dB SPL/earpiece

at 1 mW/earpiece

Weight : 78 g (0.17 lb)

Finish : Black/grey



Single pair of replacement ear pads: ordering code 8222 321 16451.

8.3 LBB 3306 Extension Cables

To interconnect 6-channel interpreter desks when the standard cable is too short.

Product Variants:

- LBB 3306/05: 5 m extension cable assembly with 25-pole sub-D-type plug and socket
- LBB 3306/20: 20 m extension cable assembly with 25-pole sub-D-type plug and socket
- LBB 3306/00: 100 m installation cable without connectors

**Physical characteristics:**

Type of connectors : 25-pole sub-D-type plug
with sliding lock mechanism

: 25-pole sub-D-type socket

with pin-lock mechanism

Finish : Grey sheath

9. DCN

Digital Congress Network equipment

The Integrus language distribution system can be used with the Digital Congress Network (DCN). The range of DCN equipment uses advanced digital technology to meet the demands of modern discussion, conference and congress venues. The system comprises an extensive range of compact modular DCN units which can be assembled to produce the configuration most suited to the conference requirements. Every requirement of modern conference management is catered for, including simultaneous interpretation of languages, information display and electronic voting.

DCN technology offers high-quality audio, free from distortion and with excellent speech intelligibility, for all conference delegates, with no loss in signal quality during transmission. Because DCN uses only a single cable to carry all the system's digital signals, installation is easy and economical. By simply daisy-chaining the modular DCN units, any configuration can be put together quickly and easily. DCN technology also allows modules to be easily inserted at any point in the system cabling, so systems can be easily expanded to meet changing requirements. Software control and PC control is also possible. Small configurations do not require an operator, and even complex configurations can be monitored by a single operator.

Interpreter desks

The convenient DCN interpreter desk eases the task of the interpreter. The most relevant incoming languages can be preselected, thus reducing the chance of operating errors while the conference is in progress.

The alphanumeric display gives an at-a-glance indication of the selected language, plus the 'quality level' of the incoming language, i.e. whether it is a primary or secondary interpretation.

Relay interpretation caters for less well known languages. The DCN can handle up to 15 simultaneous interpretation language channels, plus the floor language. Unused channels are automatically filled in with the floor language.



Product index

(Page numbers refer to descriptions.)

Transmitters

LBB 4502/04	4-Channel Transmitter	4.1
LBB 4502/08	8-Channel Transmitter	4.1
LBB 4502/16	16-Channel Transmitter	4.1
LBB 4502/32	32-Channel Transmitter	4.1

Interface module

LBB 3422/10	Symmetrical Audio Input and Interpreters Module	4.3
LBB 3423/00	DCN Interface Module	4.2

Infra-red radiators

LBB 4511/00	Medium-Power Radiator	5.1
LBB 4512/00	High-Power Radiator	5.1
LBB 3414/00	Wall Mounting Bracket	5.2

Infra-red receivers

LBB 4540/04	4-Channel Pocket Receiver	6.1
LBB 4540/32	32-Channel Pocket Receiver	6.1
LBB 4550/00	NiMH Battery Pack	6.2

Charging units

LBB 4560/00	Charging Suitcase	6.3
LBB 4560/50	Charging Cabinet	6.3

Storage suitcases

Audipack 6402	Suitcase for 100 LBB 4540 Pocket Receivers	6.3
Audipack 13891	Suitcase for LBB 4511/00 Medium Power Radiator	5.2
Audipack 13892	Suitcase for LBB 4512/00 High Power Radiator	5.2

Headphones

LBB 3015/04	High Quality Dynamic Headphones	7.4
LBB 3441/00	Under The Chin Headphones	7.2
LBB 3442/00	Single Earphone	7.3
LBB 3443/00	Lightweight Stereo Headphones	7.1

6-channel interpreter desk

LBB 3222/04	6-Channel Interpreter Desk with Loudspeaker	8.1
LBB 3306/00	100 m installation cable without connectors	8.3
LBB 3306/05	5 m extension cable assembly with 25-pole sub-D-type plug and socket	8.3
LBB 3306/20	20 m extension cable assembly with 25-pole sub-D-type plug and socket	8.3
LBB 9095/30	Interpreter Headphones	8.2

DCN

DCN	Digital Congress Network equipment	9
-----	------------------------------------	---

